

18V 4113

VW Crafter MAN TGE, Md. 01/2017

EU-pedestrian protection bar 60 mm

EU-Personenschutzbügel 60 mm

Protection avant, homologuée CEE, 60 mm

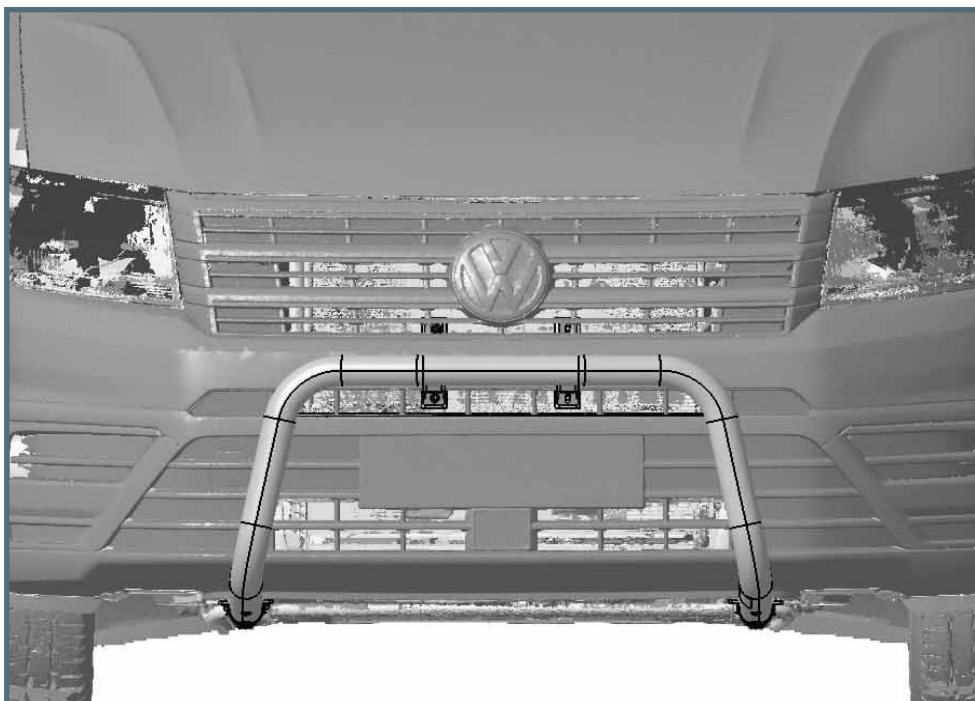

ASSEMBLY INSTRUCTION

Montageanleitung • Instructions de montage

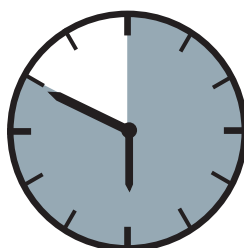

50 Minuten

article no.:
18V4113(S) inox
18V5113 black steel

Revision 3: 15.06.2023

www.antec-online.de

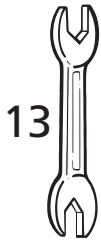

M8:
25 Nm
M8 (A2):
21,4 Nm

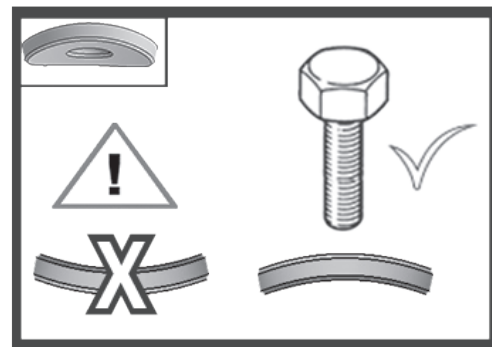
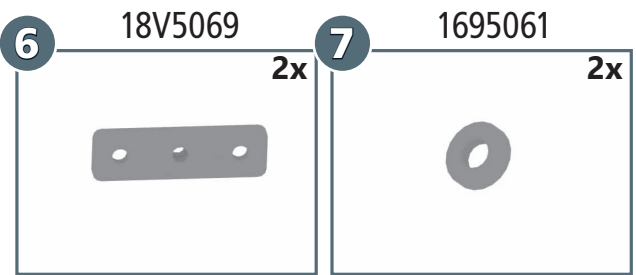
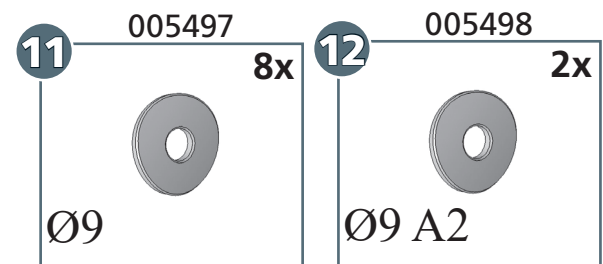
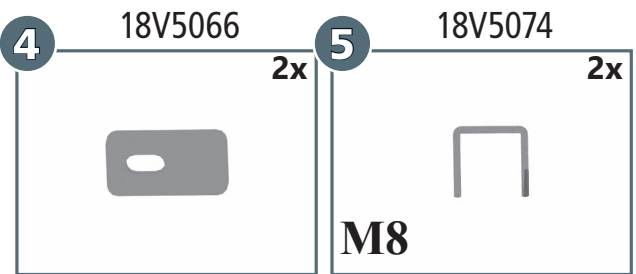
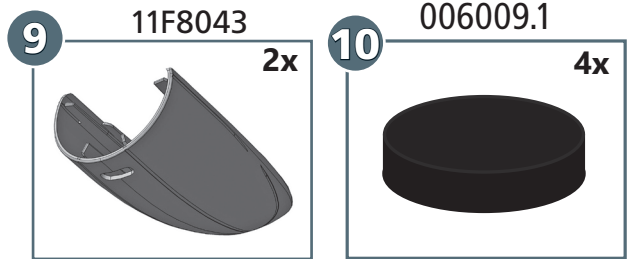
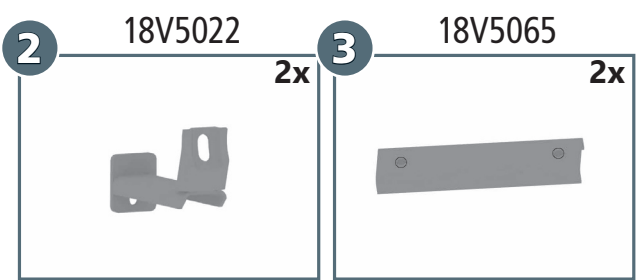
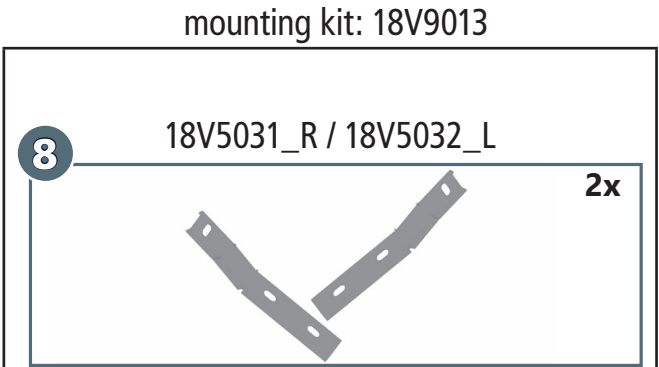
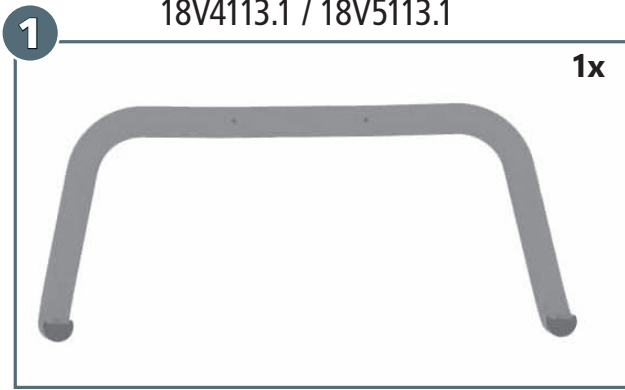
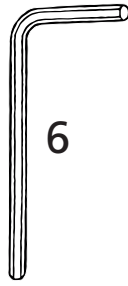







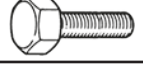
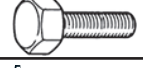

article no.:
18V4113(S) inox
18V5113 black steel

Revision 3: 15.06.2023



mounting kit: 18V9013

	M8x20; DIN 912 A2	4x
	M8x30; DIN 912 Zn	4x
	M8x25; DIN 933 A2	2x
	M8x30; DIN 933 Zn	2x
	Ø 3,5x13 (DIN ähnl.7981 B) A2	2x
	M8; DIN 934 Zn	4x
	Ø 4,2; DIN 9021 A2	2x
	Ø 8,4; DIN 125 Zn	2x
	Ø 8,4; DIN 125 A2	4x
	SW 13	2x

article no.:
18V4113(S) inox
18V5113 black steel

Revision 3: 15.06.2023



