

11E
4513

Toyota Hilux, Modell 2016+2019

EU-Personenschutzbügel 70 mm
EU-Pedestrian Protection Bar 70 mm
Protection avant, homologuée CEE, 70 mm



*Compatible with Automatic Cruise Control /Forward Collision Mitigation
Kompatibel mit Abstandsregeltempomat /Auffahrvermeidungs-oder warnsystem
compatible avec radar de régulation de distance/ freinage autonome d'urgence



ASSEMBLY INSTRUCTION

Montageanleitung • Instructions de montage

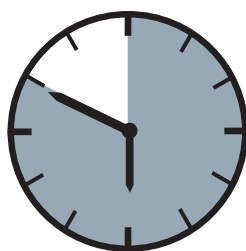

50 Minuten

Artikel-Nr:
11E4513 Stainless Steel
11E5513 Steel black

Revision 9: 13.09.2021



M6:
10 Nm
M8 (A2):
21,4 Nm
M12:
87 Nm

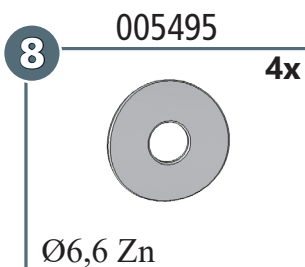
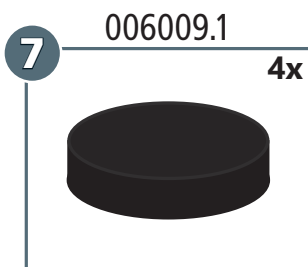
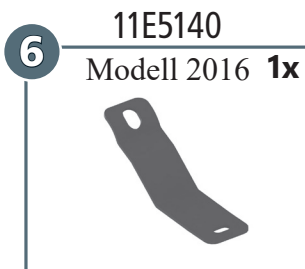
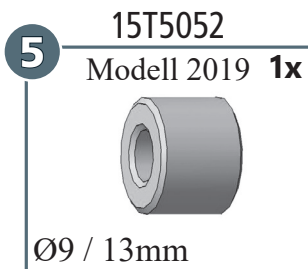
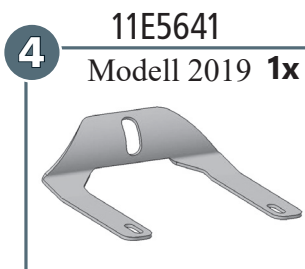
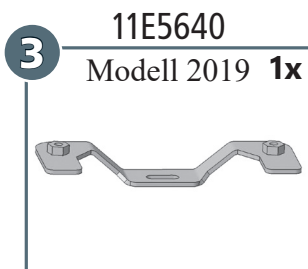
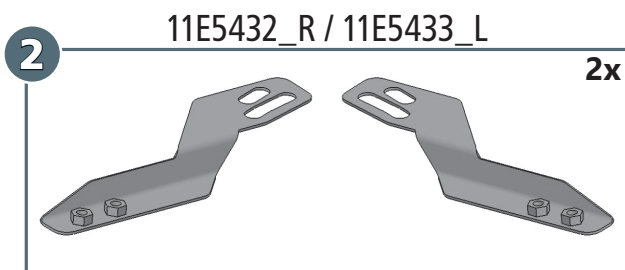
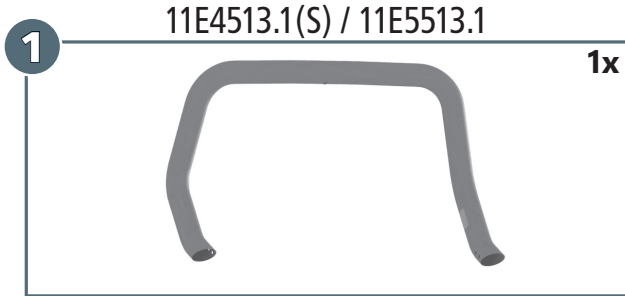
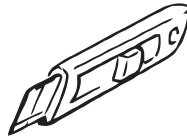

mounting kit: 11E9513

	M6x25; DIN 933 Zn	3x
	M6x35; DIN 933 Zn	1x
	M8x25; DIN 933 A2	1x
	M12x1,25x30; DIN 961 Zn	2x
	M8x25; ähnl. ISO 7380 A2	4x
	M6; DIN 934 Zn	1x
	Ø8,4; DIN 9021 Zn	1x
	SW13	1x

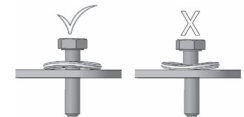
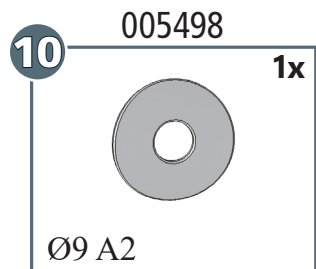
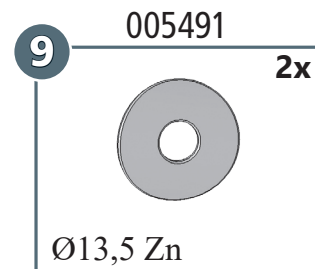

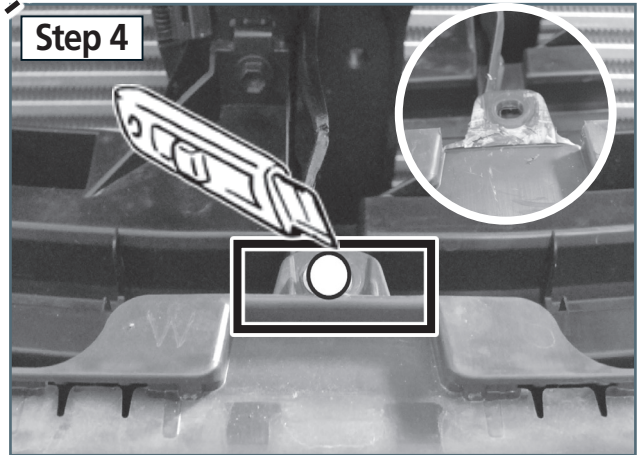
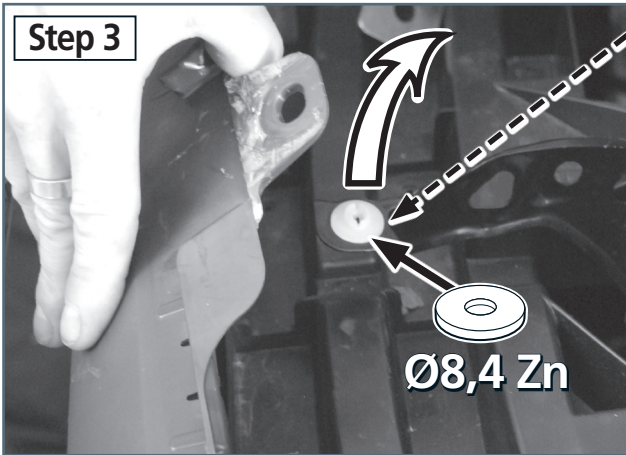
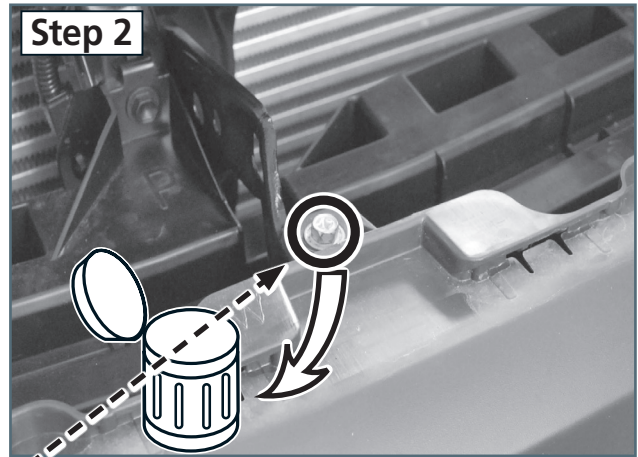
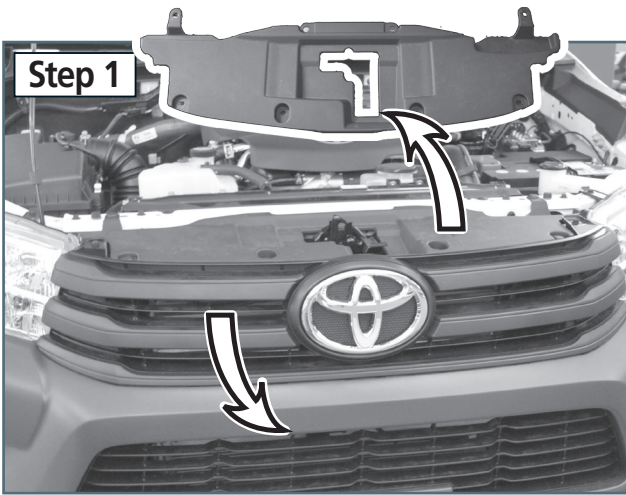

Modell 2016

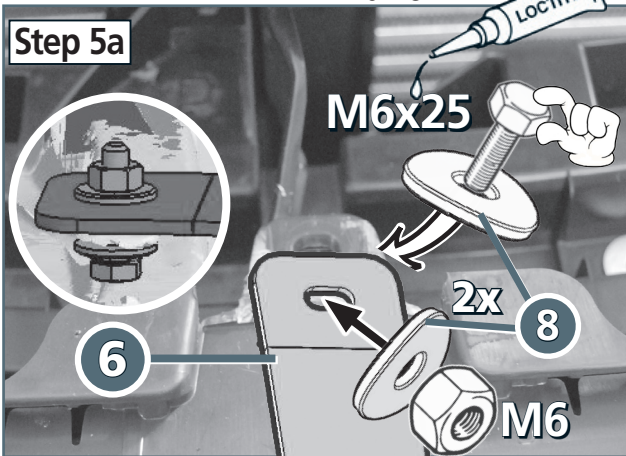

Modell 2019

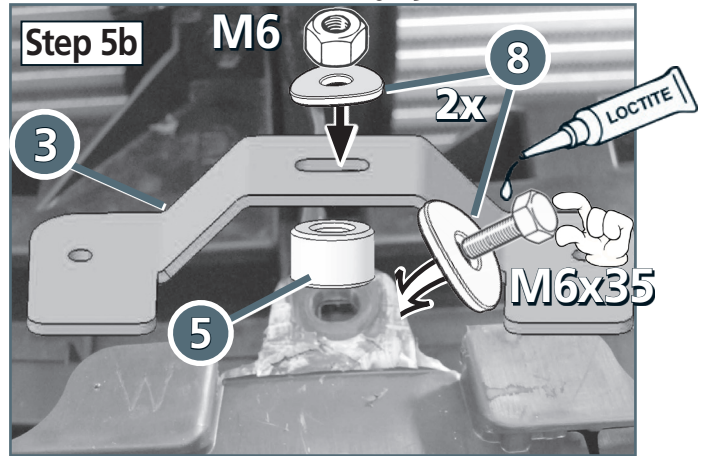

Modell 2016

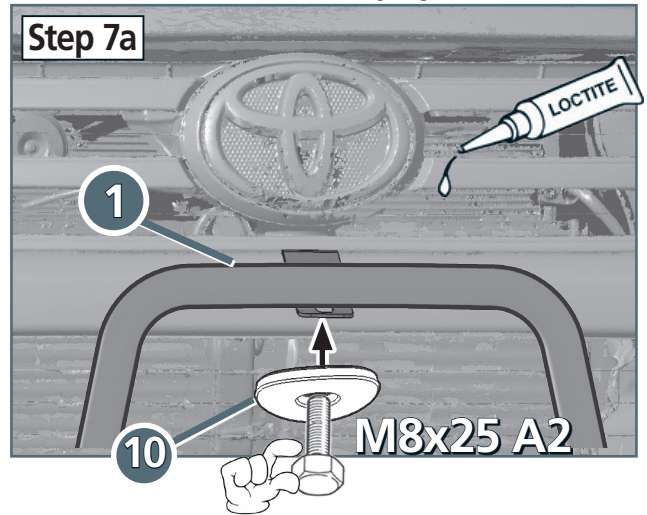
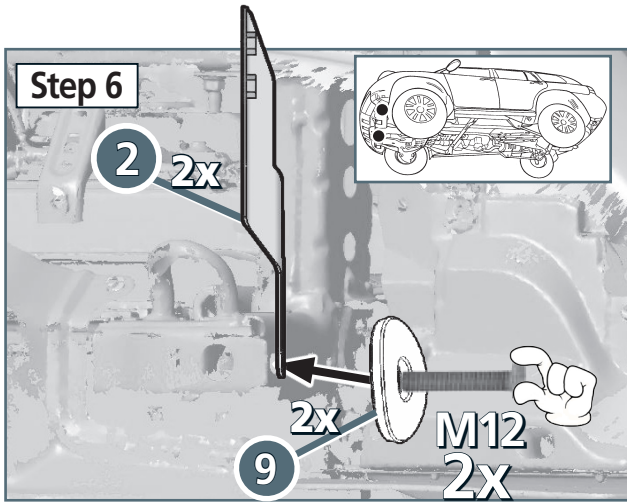

Modell 2019

