



STEELER

SOKÓŁKA

www.steeler.pl

HYUNDAI TUCSON 2015



INSTRUKCJA MONTAŻU

(Orurowania przednie niskie)

FITTING INSTRUCTION

(Front bullbar)

Инструкция монтажа

(Кенгурин)

MONTAGEANLEITUNG

(Frontschutzbügel)

TUCSON-R1570

TUCSON-R1570-03

TUCSON-R1570-04



Orurowania z homologacją „e”

Bullbar with homologation „e”

Тюнинг с омологацией „e”





Frontschutzbügel mit „e“- Prüfzeichen

Wykaz elementów orurowania:

Specification of full assembly:

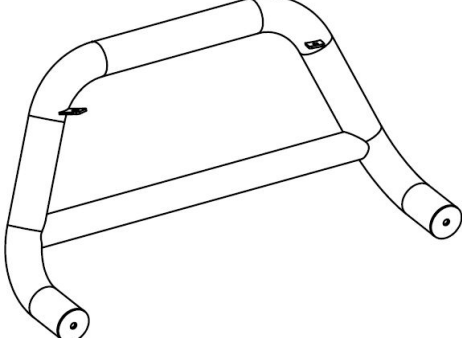
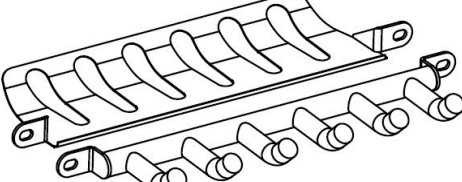
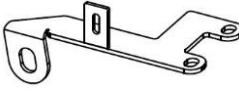
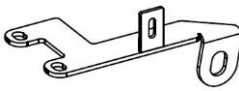
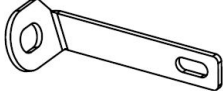
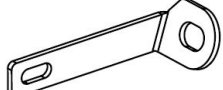
Список элементов тюнинга:

Liste der Elemente:

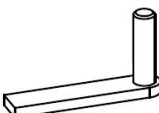
<p>1. Rura przednia (szt. 1) Bullbar (1 pc.) Передняя дуга (шт.1) Frontbügel (st.1)</p>	
<p>2. Blacha dolna / grill (szt. 1) Lower metal plate / Grate (1 pc.) Защита картера / гриль (шт.1) Unterfahrerschutz (st.1)</p>	
<p>3. Zamocowanie dolne lewe I (szt. 1) Lower left attachment I (1 pc.) Крепление нижнее левое I (шт.1) Montage unten links I (st.1)</p>	
<p>4. Zamocowanie dolne prawe I (szt. 1) Lower right attachment I (1 pc.) Крепление нижнее правое I (шт.1) Montage unten rechts I (st.1)</p>	
<p>5. Zamocowanie dolne lewe II (szt. 1) Lower left attachment II (1 pc.) Крепление нижнее левое II (шт.1) Montage unten links II (st.1)</p>	
<p>6. Zamocowanie dolne prawe II (szt. 1) Lower right attachment II (1 pc.) Крепление нижнее правое II (шт.1) Montage unten rechts II (st.1)</p>	
<p>7. Zamocowanie dolne III (szt. 2) Lower attachment III (2 pcs.) Крепление нижнее III (шт.2) Montage unten III (st.2)</p>	
<p>8. Zamocowanie górne (szt.2) Upper attachment (2 pcs.) Крепление верхнее (шт.2) Montage oben (st.2)</p>	
<p>9. Dystans (szt.2) Distance (2 pcs.) Ø22x4 L=23 Расстояние (шт.2) Distanzring (st.2)</p>	
<p>10. Dystans (szt.4) Distance (4 pcs.) Ø18x1,5 L=9 Расстояние (шт.4) Distanzring (st.4)</p>	
<p>11. Szpilka M10x35 (szt. 2) Skewer M10x35 (2 pcs.) Шпилька M10x35 (шт.2) Stecknadel M10x35 (st.2)</p>	

Wykaz elementów łącznych:
Connecting components:
Список соединительных элементов:
Die Auflistung der Elemente:

Śruby (szt.) Screws (pcs.) Болты (шт.) Schrauben (st.)	M6x90 – (2) M8x25 – (4) M8x50 – (4) M10x25 – (2) M10x35 – (2) <i>(szpilka – skewer)</i> M12x35 – (2)	Nakrętki (szt.) Nuts (pcs.) Гайки (шт.) Muttern (st.)	M6 – (2) M8 – (8) M10 – (4)
Podkładki (szt.) Washers (pcs.) Шайбы (шт.) Unterlegscheiben(st.)	Ø6,5 – (4) – XL Ø8,5 – (4) Ø 8,5 – (12) – XL Ø 11 – (6) – XL Ø 13 – (4) – XL		

M6 - 7 Nm	M8 - 17 Nm	M10 - 33 Nm	M12 - 57 Nm
-----------	------------	-------------	-------------



1 h

Czas montażu
Fitting time
Время монтажа
Montagezeit

UWAGA: Folie usunąć dopiero po montażu!

ATTENTION: Foil remove after fitting!

ВНИМАНИЕ: Целлофан снять только после завершения монтажа!

HINWEIS: Die Folie soll erst nach der Montage entfernt werden!

Montaż orurowania / Bullbar fitting / Монтаж защиты / Montage der Schwellerrohre
TUCSON-R1570-03

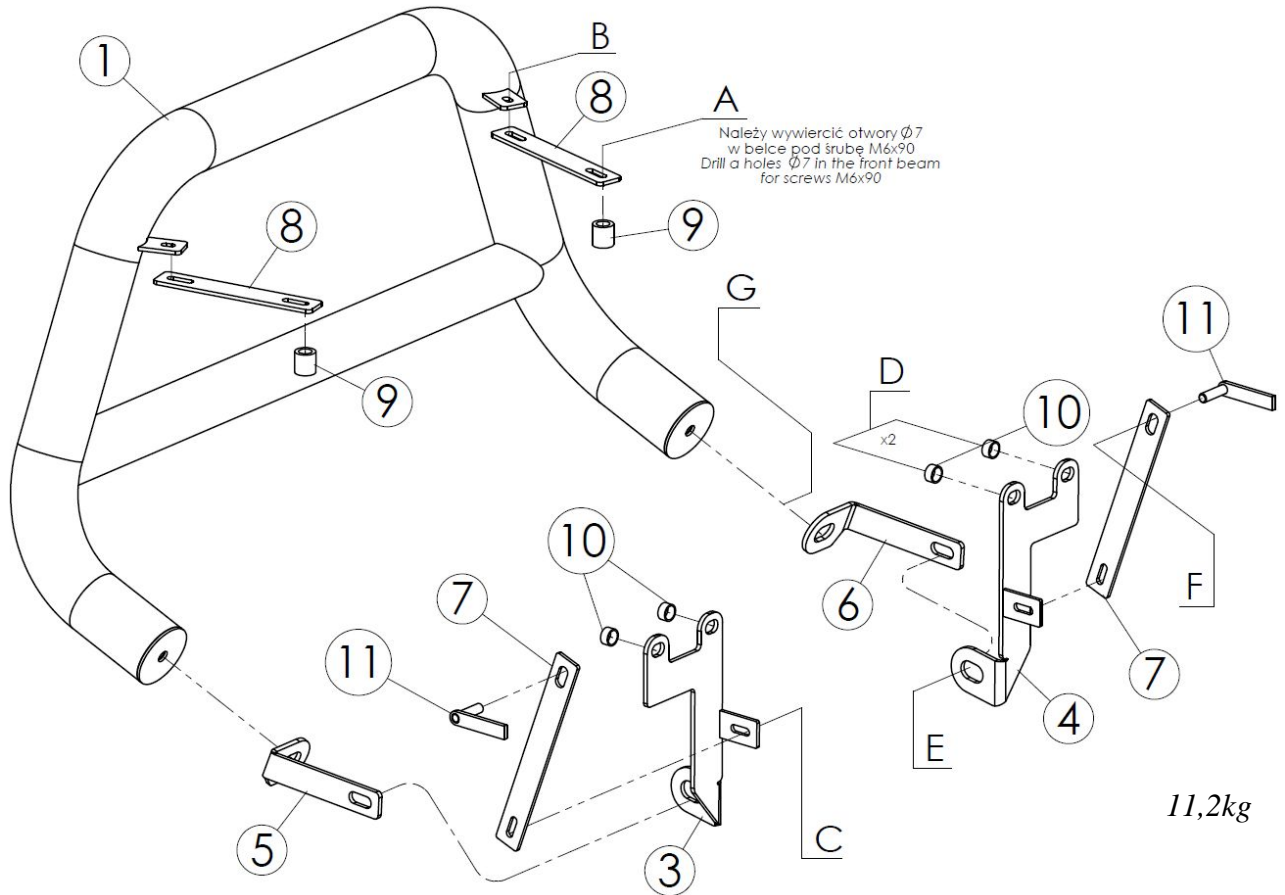

Montaż orurowania / Bullbar fitting / Монтаж защиты / Montage der Schwellerrohre
TUCSON-R1570

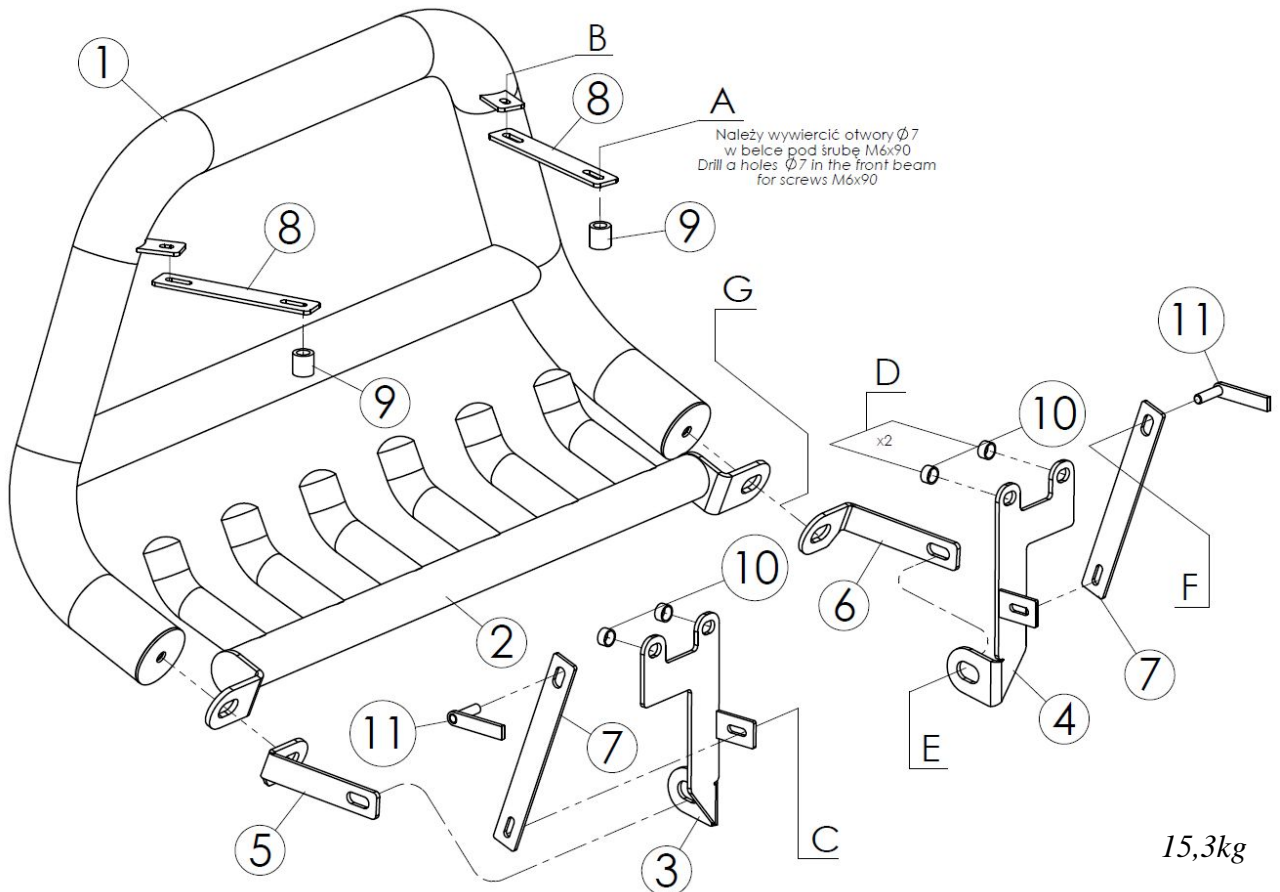

Montaż orurowania / Bullbar fitting / Монтаж защиты / Montage der Schwellerrohre
TUCSON-R1570-04

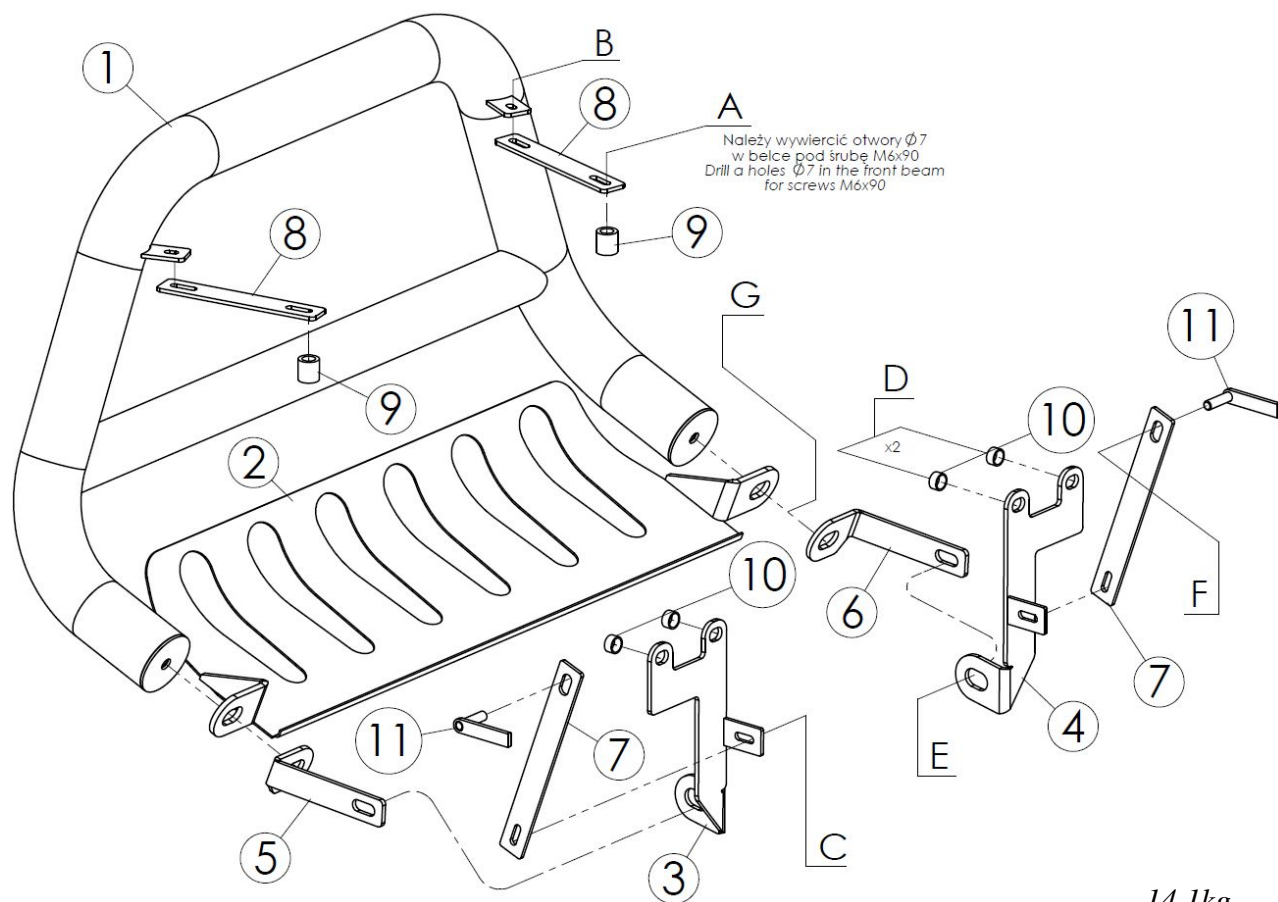

	Śruby (szt.) Screws (pcs.) Болты (шт.) Schrauben (st.)	Podkładki (szt.) Washers (pcs.) Шайбы (шт.) Unterlegscheiben (st.)	Nakrętki (szt.) Nuts (pcs.) Гайки (шт.) Muttern (st.)
A	M6x90	$\varnothing 6,5(x2)$ -XL	M6
B	M8x25	$\varnothing 8,5(x2)$ -XL	M8
C	M8x25	$\varnothing 8,5(x2)$ -XL	M8
D	M8x50	$\varnothing 8,5(x2)$ -XL	M8
E	M10x25	$\varnothing 11(x2)$ -XL	M10
F	M10x35	$\varnothing 11$ -XL	M10
G	M12x35	$\varnothing 13$ -XL	-----

F – Szpilka / Skewer / Шпилька / Stecknadel

Prawa górna część orurowania / Right upper attachments / Правая, верхняя часть защиты / Rechte, obere Seite des Frontschutzbügels

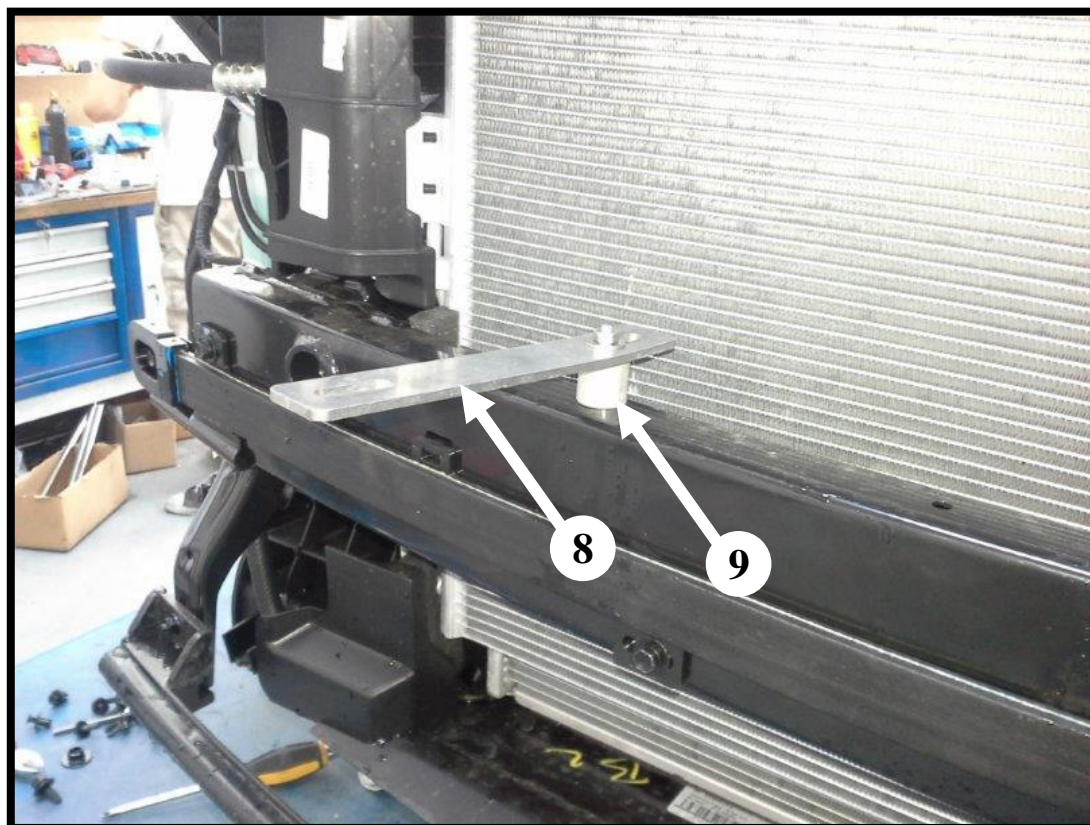
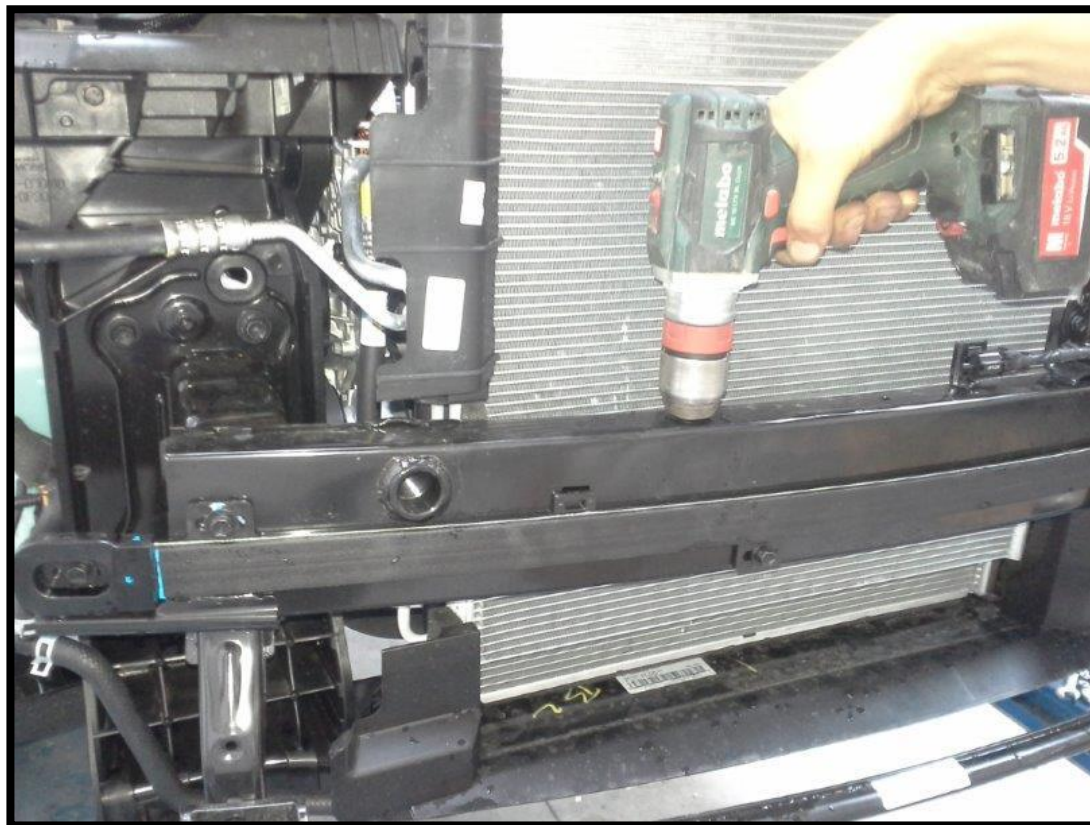

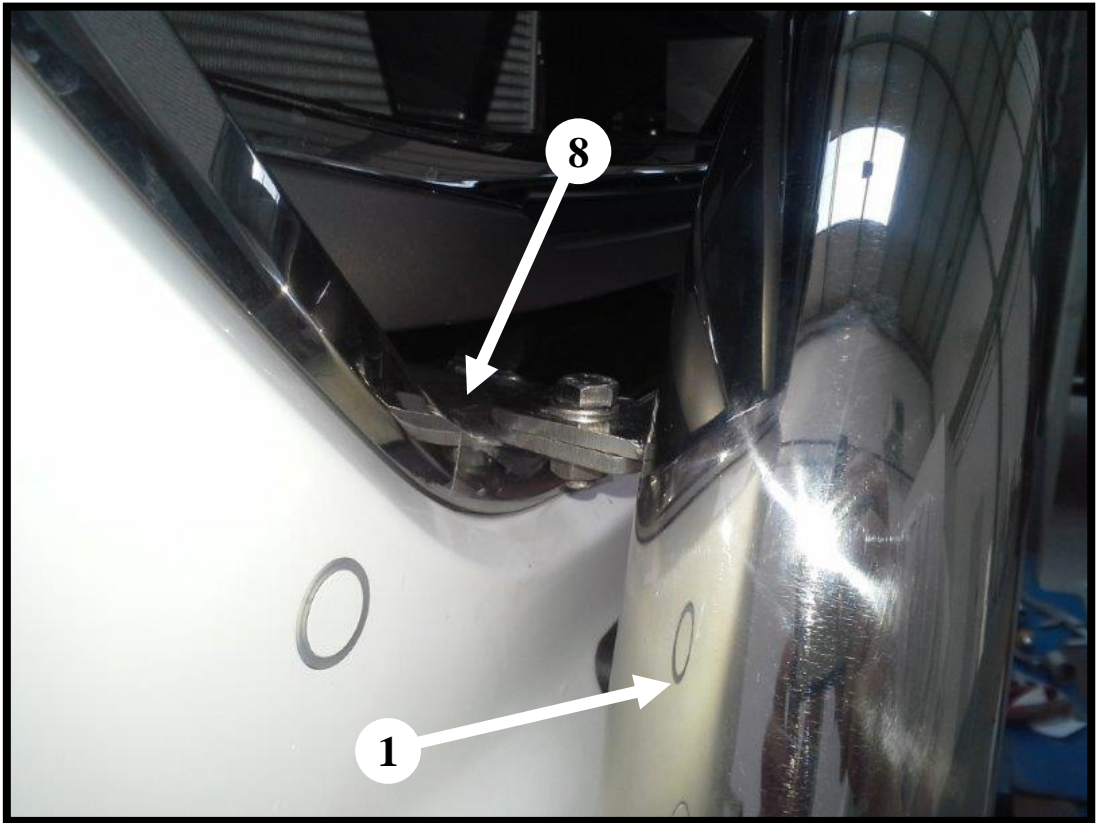
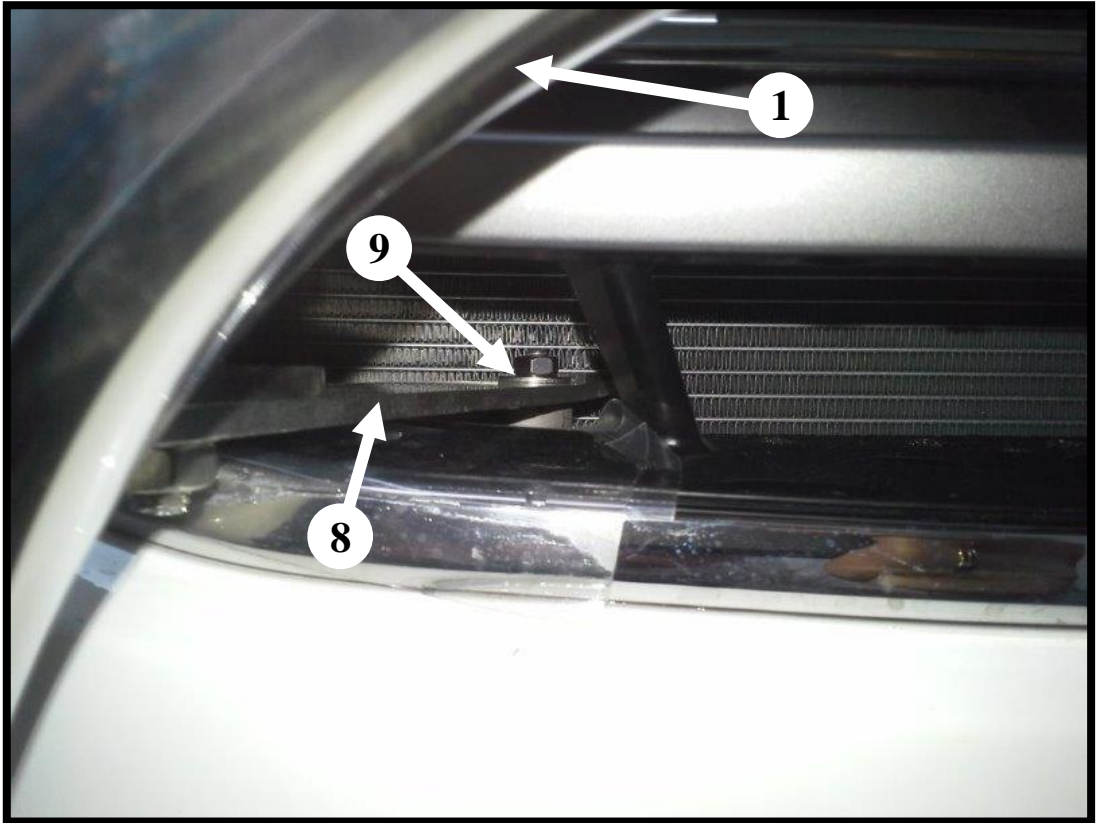

Lewa górna część orurowania / Left upper attachments / Левая, верхняя часть защиты / Linke, obere Seite des Frontschutzbügels

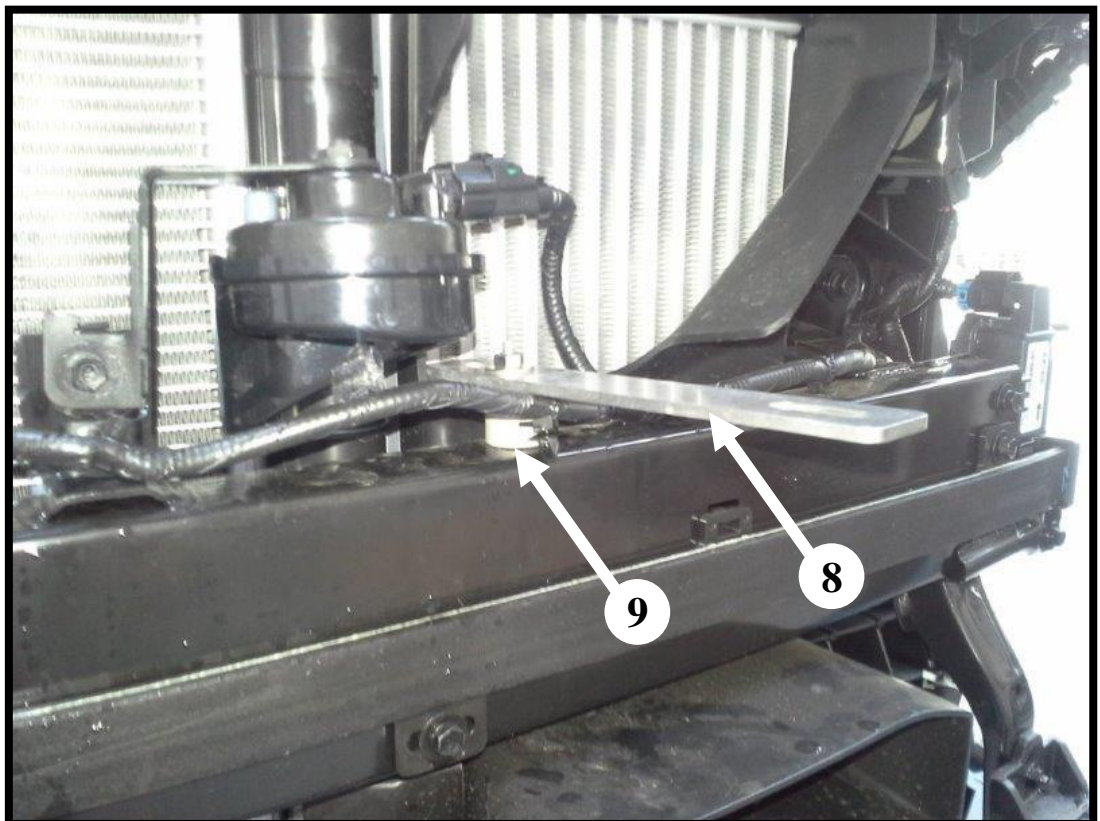
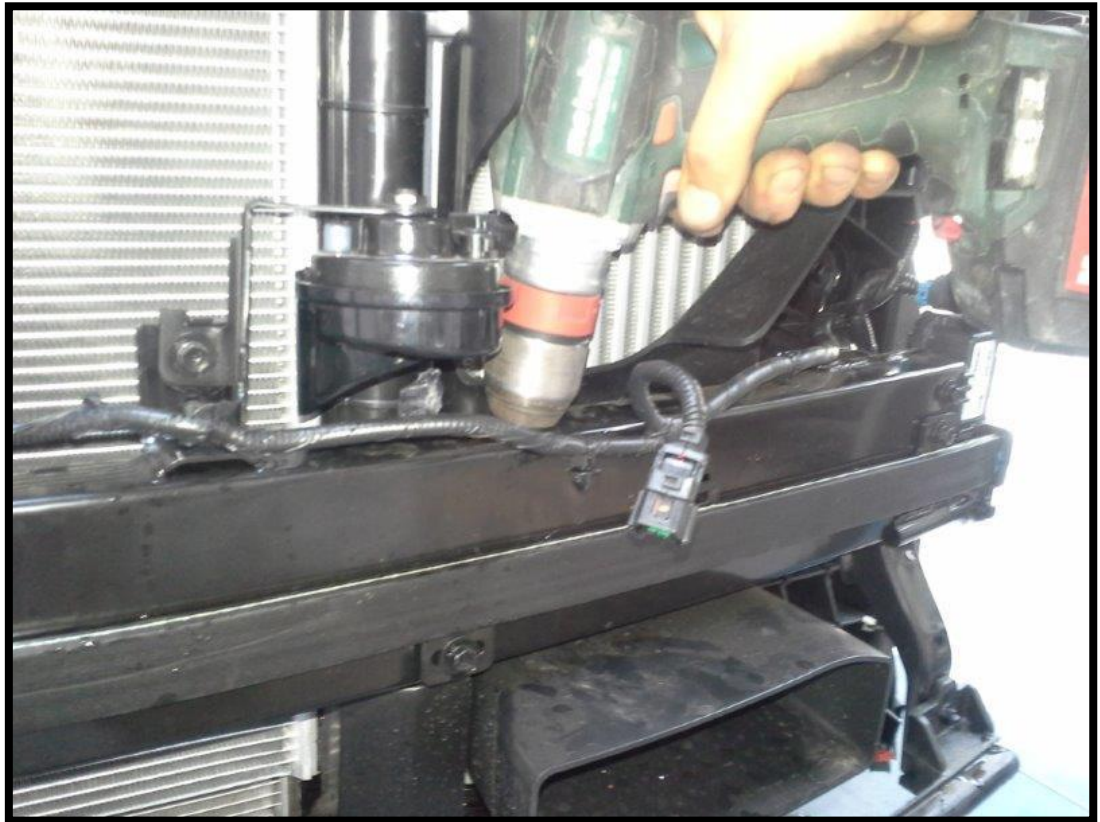

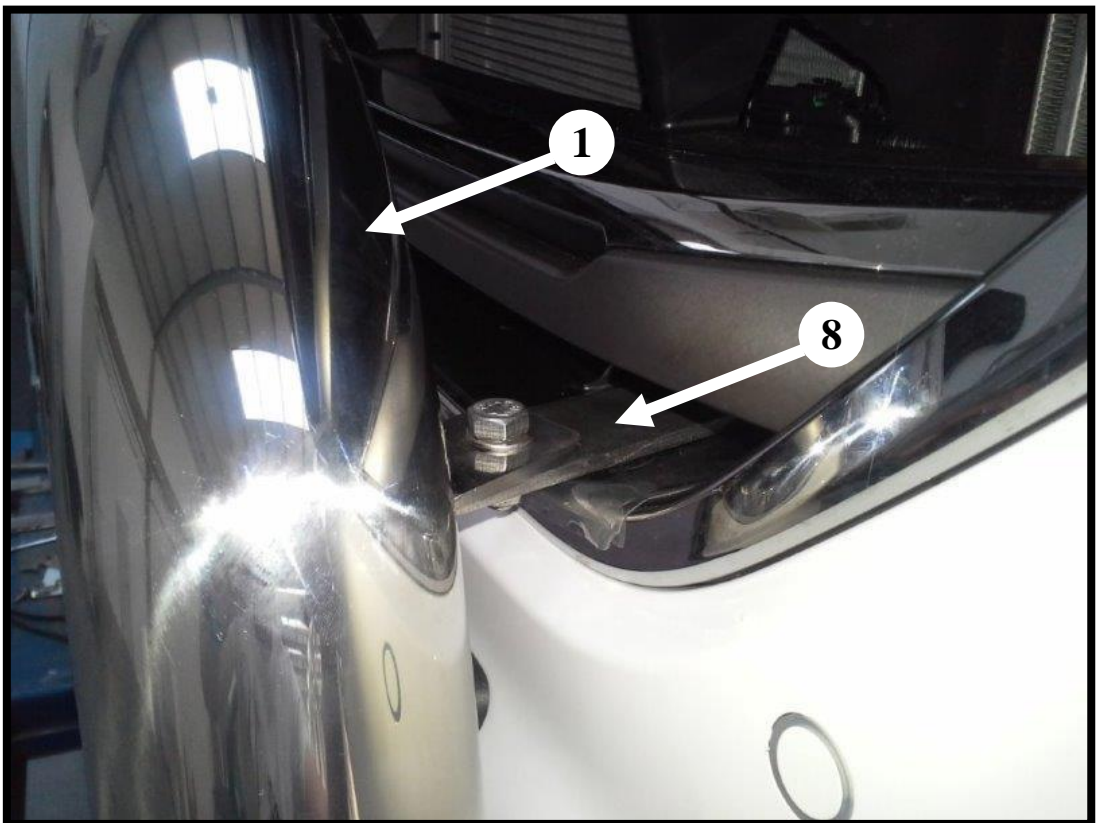
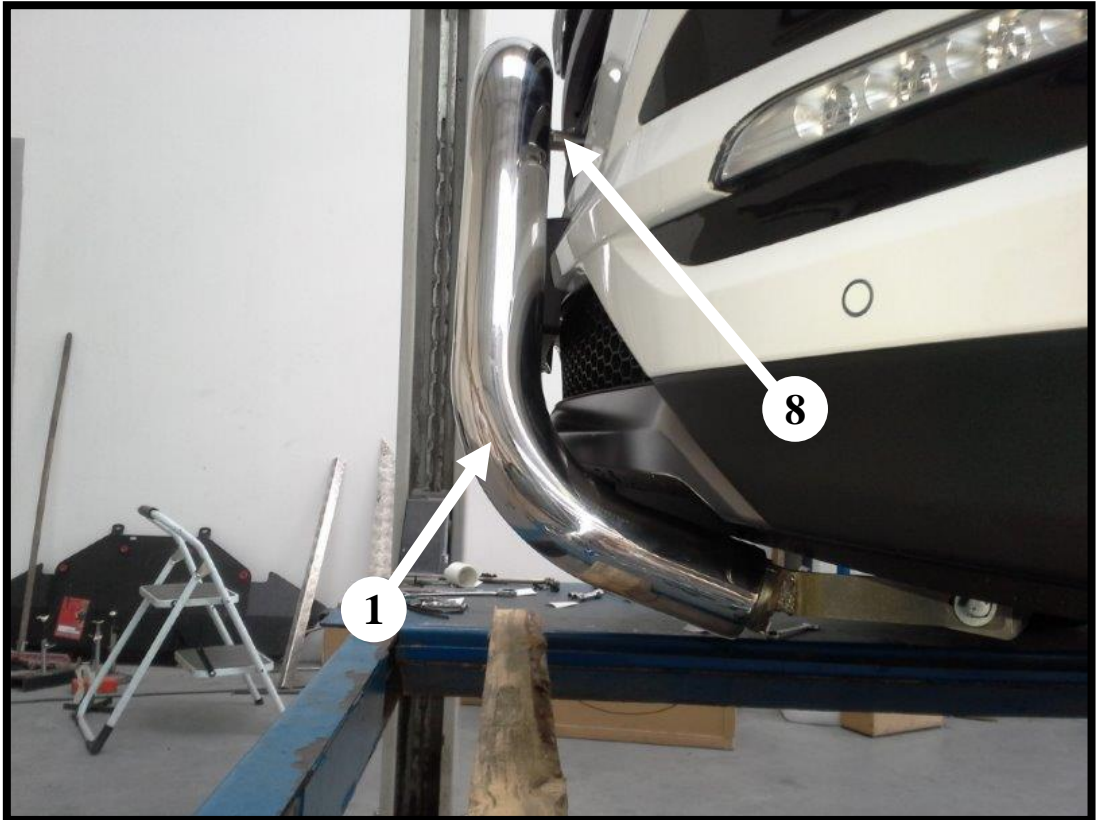

Prawa dolna część orurowania / Lower right attachments / Правая, нижняя часть защиты / Rechte, untere Seite des Frontschutzbügels



13
17
19

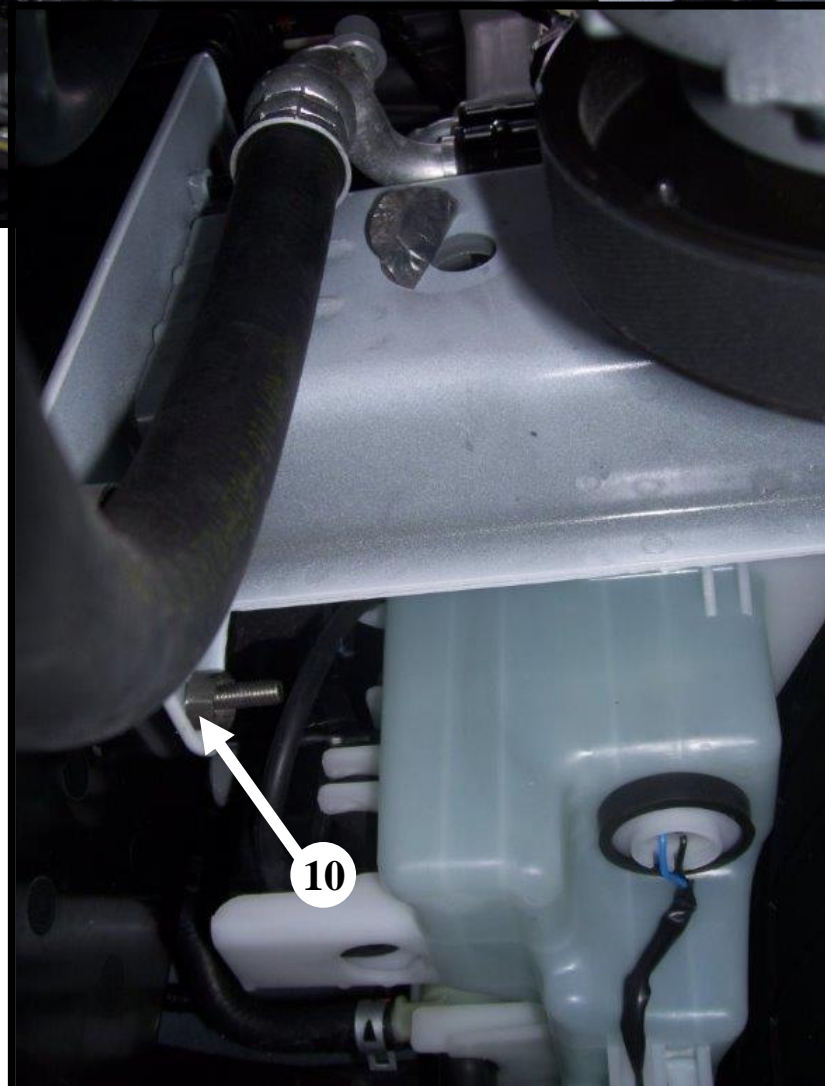
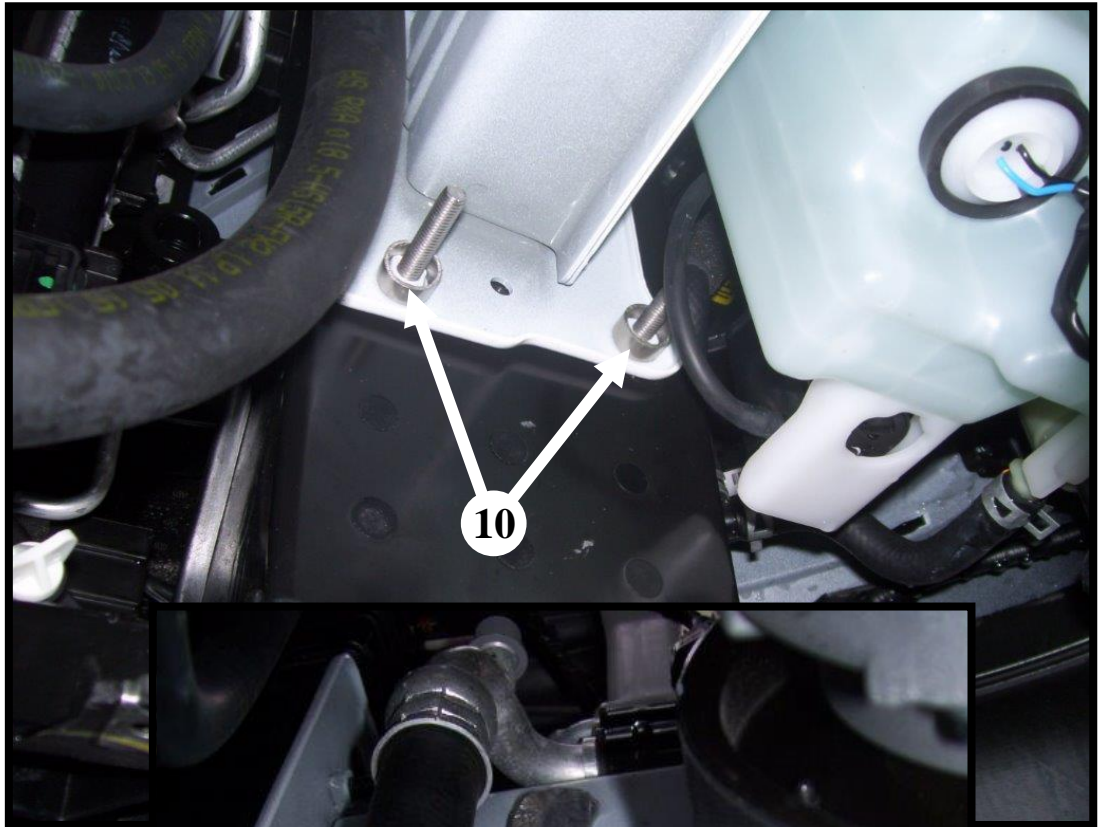

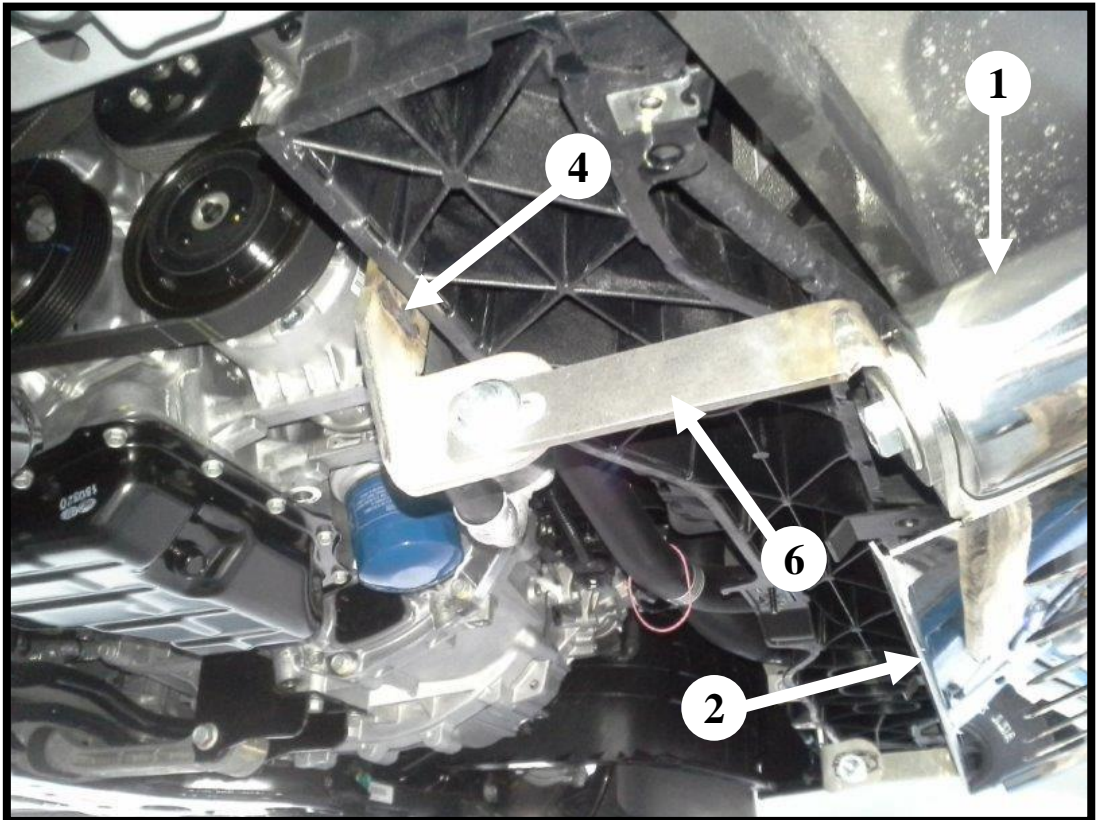
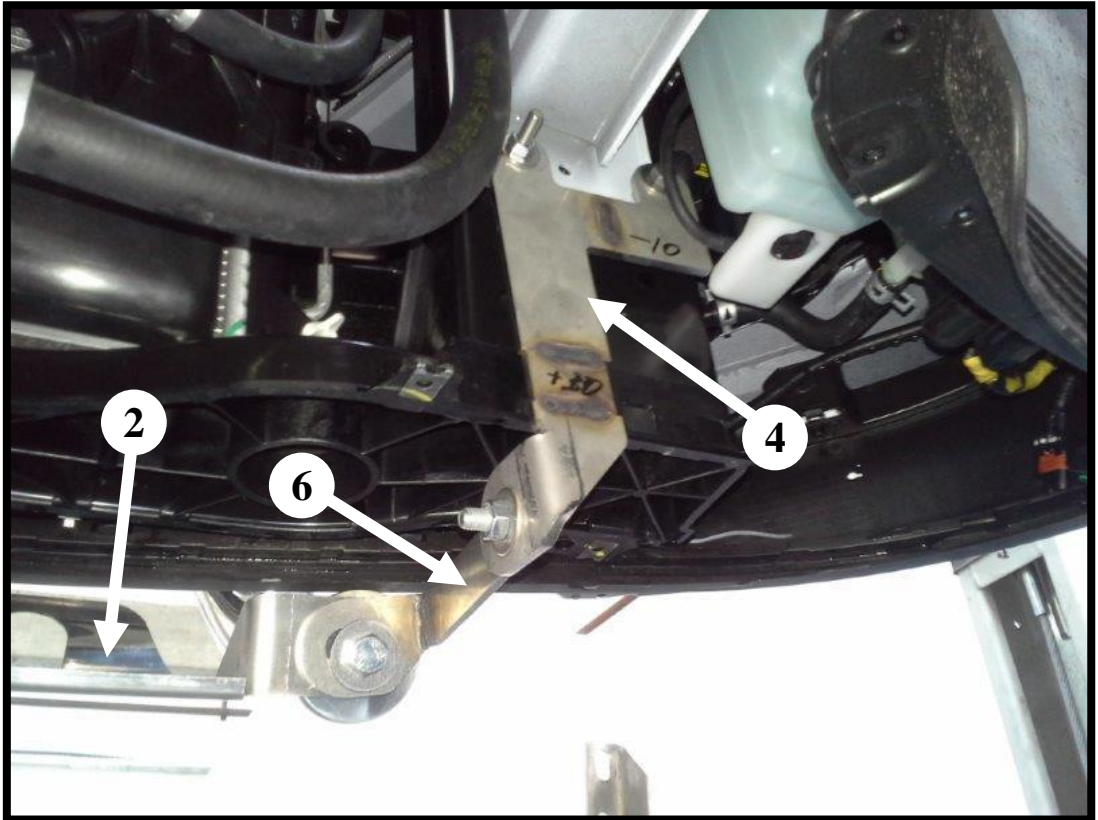

Lewa dolna część orurowania / Left, lower attachments / Левая, нижняя часть защиты / Linke, untere Seite des Frontschutzbügels

